

Premium Preparation 1800 mm Sink Unit with 2 Bowls - Left Drain

ITEM # _____

MODEL # _____

NAME # _____

SIS # _____

AIA # _____

133112 (LG1826SXEN)

 Sink Unit, with 2 bowls
 (500x500x300mm) and left-
 hand drainer, 1800mm

Short Form Specification

Item No. _____

The 50mm high worktop in 304 AISI stainless steel, 1,2mm in thickness, is sound-deadened and has an overflow rim and welded corners. Integral rear upstand, h=100mm, with 10mm radius. All-round apron panelling in 304 AISI s/s.

Round section legs and feet in 304 AISI stainless steel, 50mm in diameter. Height-adjustable feet (+0-50mm).

Single-pressed, sound-deadened bowls mm 500x500x300h with overflow pipe and drain hole (2"). Left hand drainer inclined towards the bowl.

Main Features

- Sturdiness, stability and reliability of table accurately tested.

Construction

- Round section legs with feet in 304 AISI stainless steel, 50 mm in diameter, adjustable in height by +0/-40 mm.
- 100 mm upstand with 10 mm radiused corner and 13 mm deep, designed to be used against a wall.
- 50 mm thick lower shelf, in 304 AISI stainless steel, can be easily slotted into position, 200 mm from the floor.
- Delivered in knock-down package.
- Wide range of taps are available to suit every need.
- Drainage area suitable for drying operations
- Heavy duty construction entirely in AISI 304 stainless steel to offer maximum durability.

Optional Accessories

- Lower shelf for 1800mm for units PNC 855285
- Set of 4 wheels (2 with brake) d. 100mm PNC 855288
- 3-sided underframe for 1800mm tables PNC 855293
- Elbow operated mixer tap with spout 3/4", single hole PNC 855322
- Elbow operated mixer tap with short spout 3/4", single hole PNC 855323
- Foot operated mixer tap (hot and cold) with spout 3/4" PNC 855328
- Single plastic drain syphon 2" for Sinks PNC 895313

APPROVAL: _____

Front

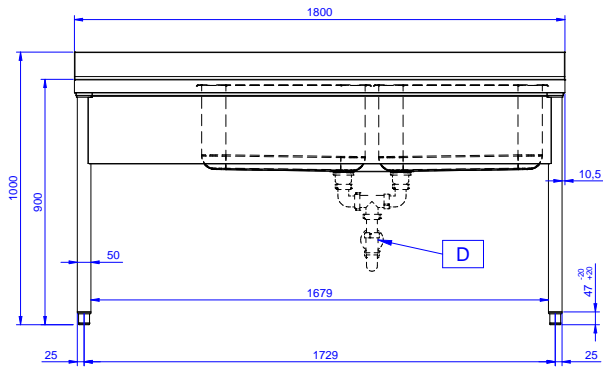

Side

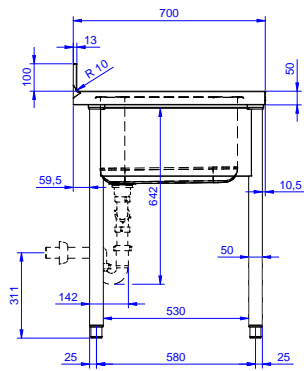

D = Drain

Top

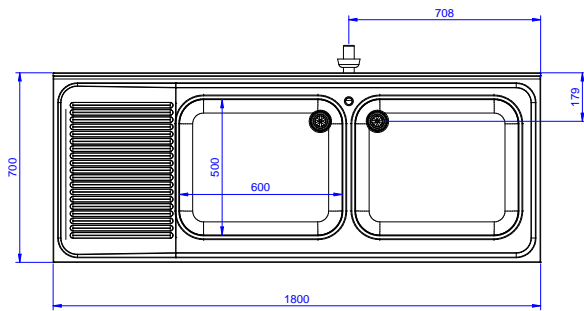



Electrolux
PROFESSIONAL

Premium Preparation 1800 mm Sink Unit with 2 Bowls - Left Drain

Key Information:

External dimensions, Width:	
133112 (LG1826SXEN)	1800 mm
External dimensions, Depth:	700 mm
External dimensions, Height:	900 mm
Upstand Dimensions, Height:	100 mm
Upstand Dimensions, Depth:	13 mm
Upstand Dimensions, Radius:	R=10
Bowls number	2
Bowl dimensions	600x500xH320
Worktop thickness:	50 mm
Net weight:	51 kg



Premium Preparation
1800 mm Sink Unit with 2 Bowls - Left Drain

The company reserves the right to make modifications to the products
without prior notice. All information correct at time of printing.

2026.06.22